



US008209000B2

(12) **United States Patent**  
**Kuo et al.**

(10) **Patent No.:** **US 8,209,000 B2**  
(45) **Date of Patent:** **\*Jun. 26, 2012**

(54) **DEVICE FOR SENSING PHYSIOLOGICAL SIGNAL AND METHOD FOR SENSING THE SAME**

(58) **Field of Classification Search** ..... 600/508, 600/509, 516, 517, 515  
See application file for complete search history.

(75) Inventors: **Bo-Jau Kuo**, Taipei (TW); **Ching-Hsiu Yang**, Taipei (TW)

(56) **References Cited**

(73) Assignee: **National Yang Ming University**, Taipei (TW)

U.S. PATENT DOCUMENTS

- 4,680,708 A \* 7/1987 Ambos et al. .... 600/509
- 4,905,706 A \* 3/1990 Duff et al. .... 600/514
- 5,437,285 A \* 8/1995 Verrier et al. .... 600/515
- 6,148,228 A \* 11/2000 Fang et al. .... 600/509

(\* ) Notice: Subject to any disclaimer, the term of this patent is extended or adjusted under 35 U.S.C. 154(b) by 358 days.

\* cited by examiner

This patent is subject to a terminal disclaimer.

*Primary Examiner* — Eric D. Bertram

*Assistant Examiner* — Roland Dinga

(74) *Attorney, Agent, or Firm* — Muncy, Geissler, Olds & Lowe, PLLC

(21) Appl. No.: **12/408,797**

(57) **ABSTRACT**

(22) Filed: **Mar. 23, 2009**

A device for sensing a physiological signal comprises: two sensing units connected to the palms a subject respectively to receive a first electrocardiogram (ECG) signal; a filter for generating a second ECG signal by filtering the first ECG signal; an amplifying unit for generating a third ECG signal by amplifying the second ECG signal; an analog to digital converting unit for converting the third ECG signal into a digital signal; an operating unit for generating a plurality of analysis data by operationally analyzing the digital signal; and a display unit for displaying the plurality of analysis data. Therefore, the accuracy of the ECG is improved and the operation is simplified.

(65) **Prior Publication Data**

US 2010/0125185 A1 May 20, 2010

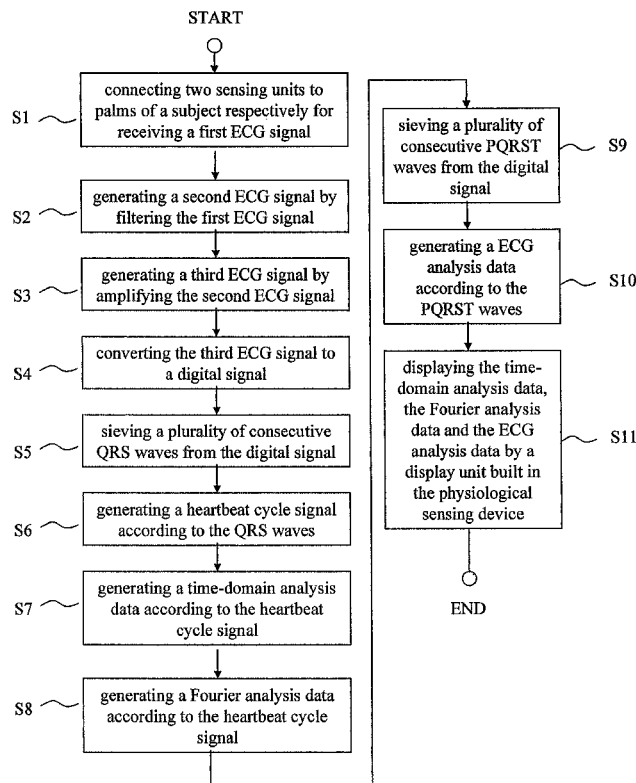
(30) **Foreign Application Priority Data**

Nov. 19, 2008 (TW) ..... 97144779 A

(51) **Int. Cl.**  
**A61B 5/04** (2006.01)

**16 Claims, 9 Drawing Sheets**

(52) **U.S. Cl.** ..... **600/509**



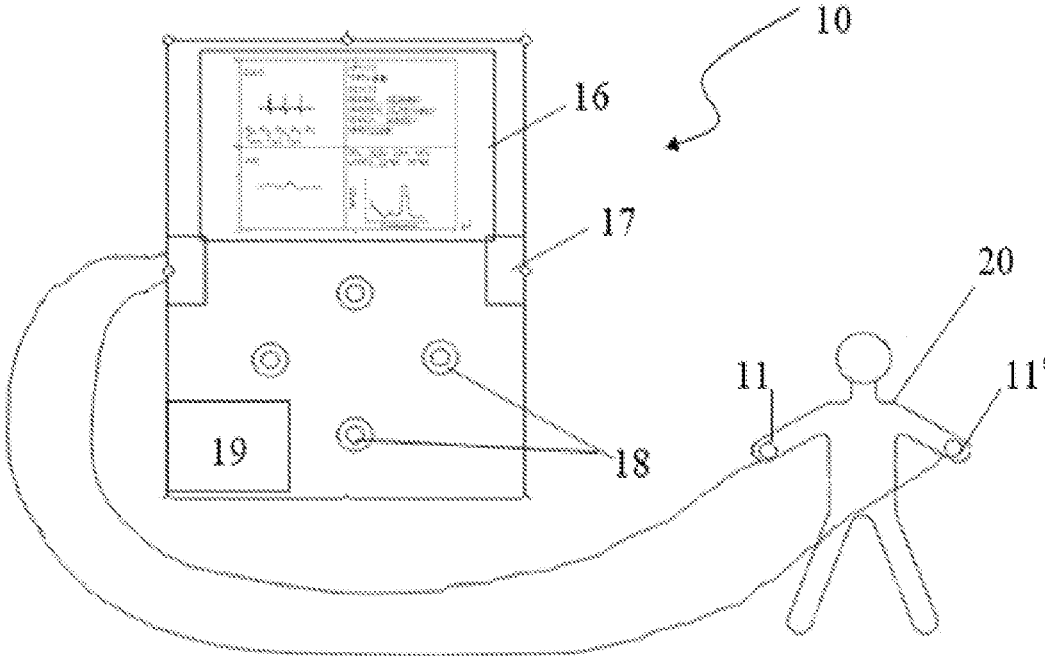


FIG.1

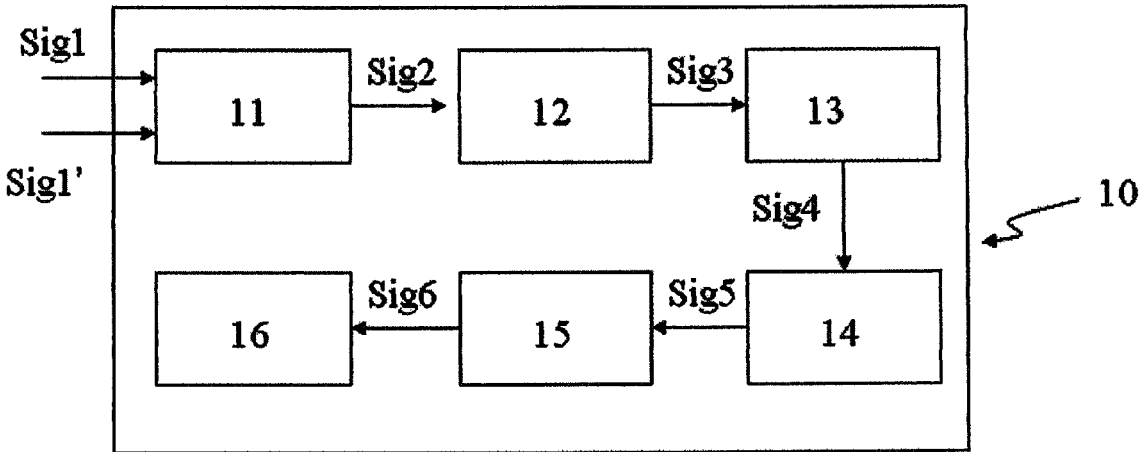


FIG.2

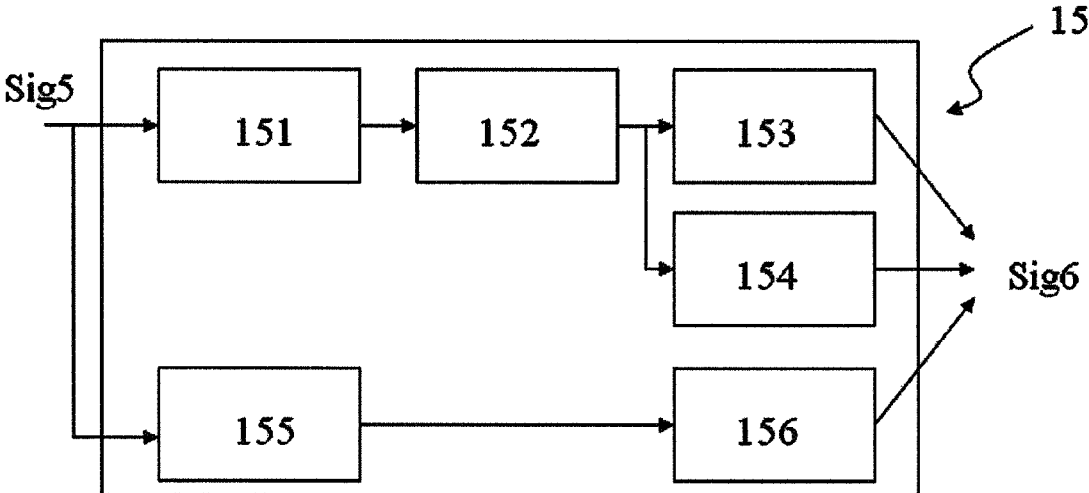


FIG.3

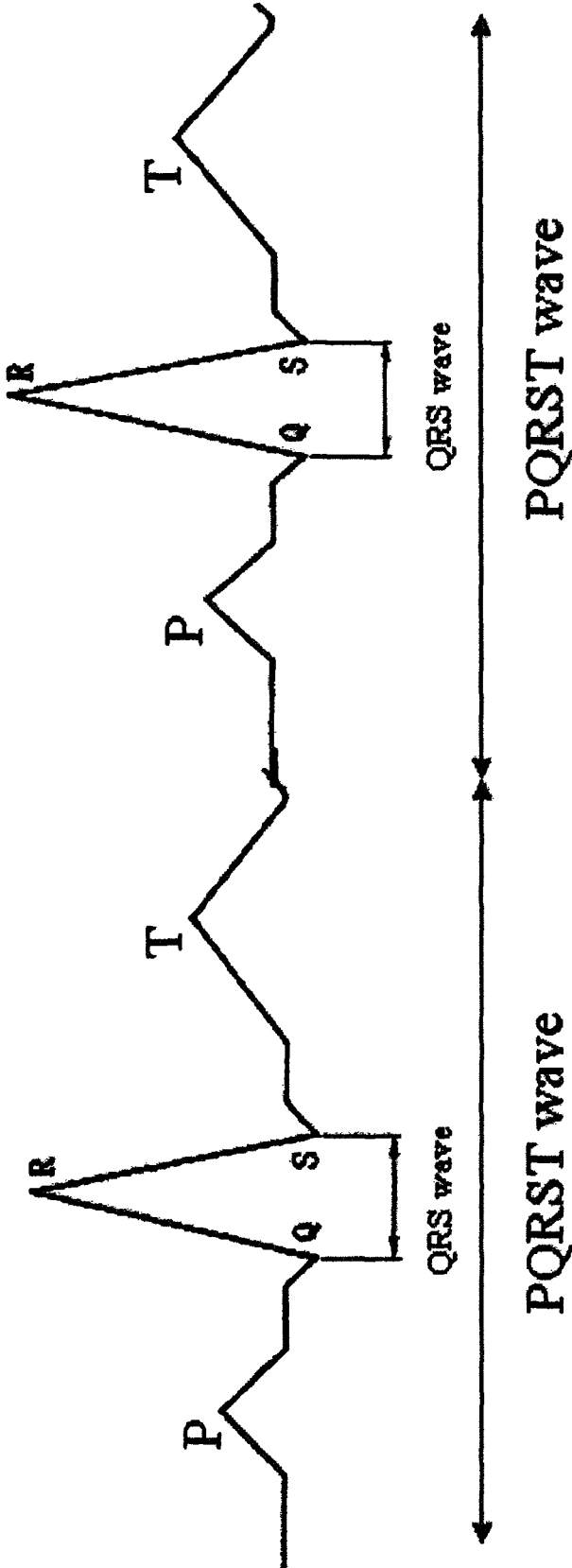


FIG.4

16





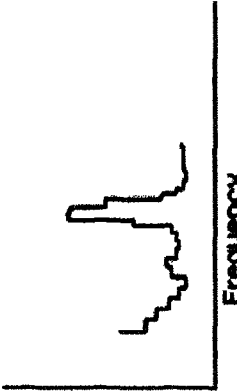
<p><b>EKG</b></p>  <p><math>A_P, A_Q, A_R, A_S, A_T, T_{P-R},</math> <math>T_{Q-T}, T_{Q-S}</math></p>	<p>HR=72 THR V parameter : SD=22 SDNN= SDANN= RMSSD= SDNN index= SDSD= pNN50 = NN50 count=</p>
<p><b>RR</b></p> 	<p>TP= VLF= LF= HF= LF/HF= LF%= HF%=</p> <p>MPSD</p> 

FIG.5

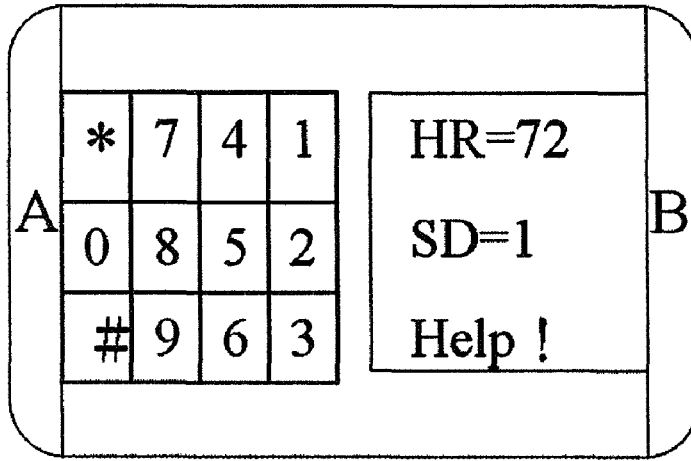


FIG. 6(a)

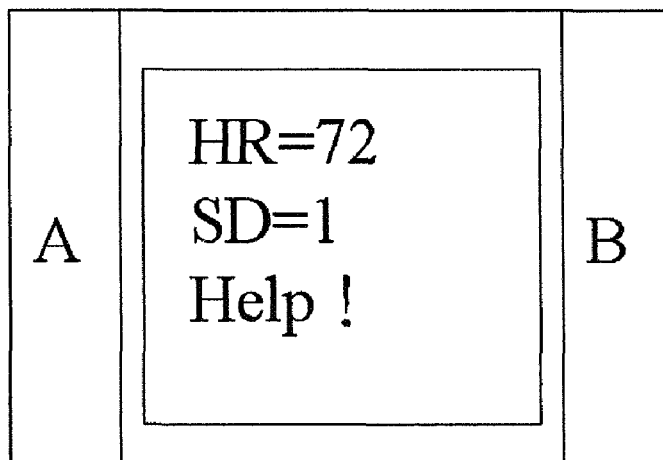


FIG. 6(b)

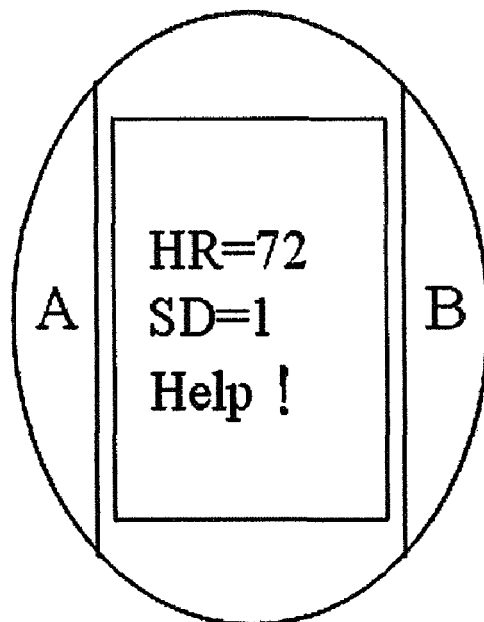


FIG. 6(c)

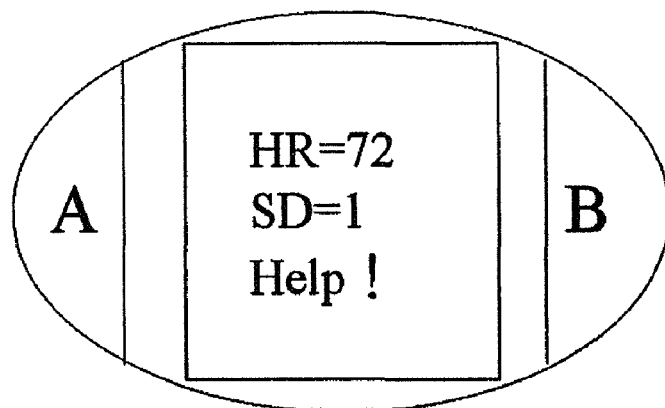


FIG. 6(d)



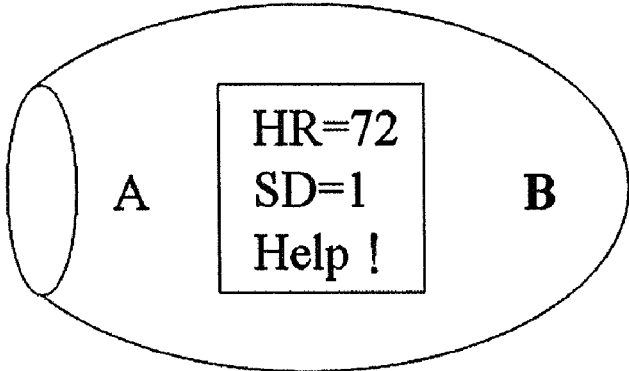


FIG. 6(e)

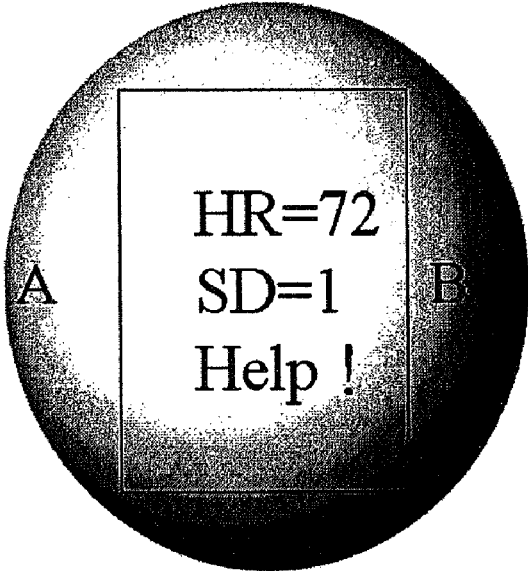


FIG. 6(f)

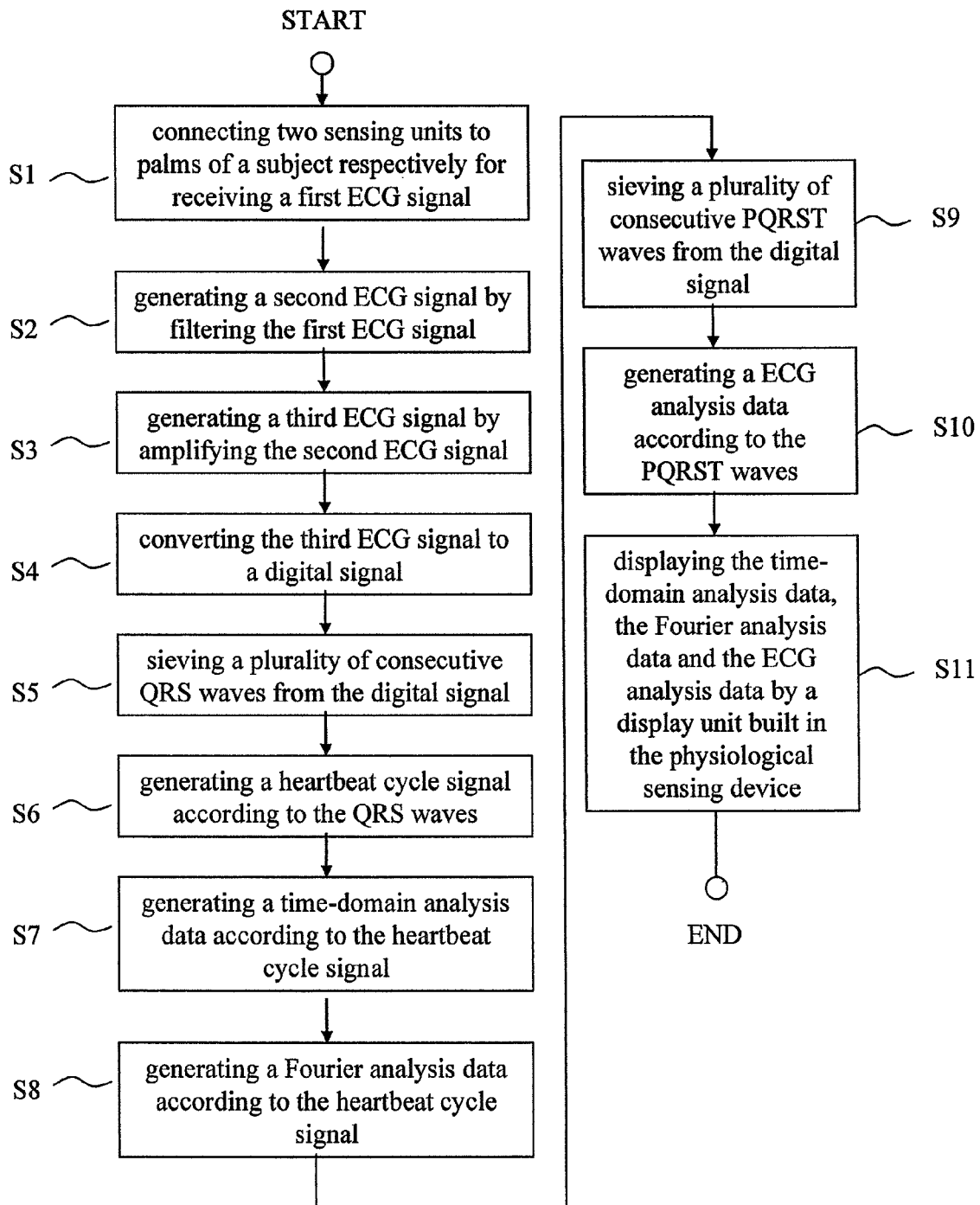


FIG. 7

1

## DEVICE FOR SENSING PHYSIOLOGICAL SIGNAL AND METHOD FOR SENSING THE SAME

### BACKGROUND OF THE INVENTION

#### 1. Field of the Invention

The present invention relates to a physiological signal sensing device, and more particularly, to a device with its sensing method that is easy to operate for sensing physiological signals and improving the accuracy of records for electrocardiogram (ECG).

#### 2. Description of the Related Art

It is known that the heart is an organ composed by muscles. However, the muscle that composes heart is different than other muscles (striated muscle, such as arms, legs, chest muscles). It is called "myocardium". When the heart is active, current is generated by heart beating and electrocardiogram (ECG) is a picture that records the change of this current.

From ECG, we can diagnose the shape changes of heart caused by arrhythmia and all kinds of heart diseases. From the changes of ECG, we can know whether the heart beating is regulative or not (i.e. arrhythmia). The main reason of causing arrhythmia is when there is a problem at a certain part or point of conduction system in heart. From the changes of different ECG pictures, we can understand which point of the conduction system is abnormal. In addition to the conduction system diseases, the changes of electrocardiogram follow the heart shape changed by whatever reasons. For example, when the workload of the heart is increased by long-term high blood pressure or heart valve diseases, myocardium hypertrophies will be thickened to cope with the increased workload. Meanwhile, the current of heart is also changed so as to change the shape of ECG. Therefore, from the changes of ECG, we can know if there is myocardium hypertrophy and also indirectly know if there is any cardiac disease to increase the workload of myocardium.

The present electrocardiogram or heart rate variability analysis facilities all complete the analysis and the collection of the electrocardiogram by customized lines and a customized program. These customized lines are comprised of complex amplifier circuit, and the analysis programs which are expensive and customized as well have to run in the very expensive PC or workstation.

The price of hardware-related is often more than ten thousand NTD, and the price of computer is above twenty thousand NTD. The range of the price of software is large, which can range from two thousand to one million NTD. The total cost is extremely high, which would cause serious limit and impact on extension and application of this technology.

Because most of the electrocardiogram measuring instruments are very expensive and the size is large, most of the ECG is operated in hospitals; and very few people would like to purchase one to put at home. It would cause inconvenience to the people.

Therefore, it is desirable to let people gain their own ECG correctly at any time without going to a hospital, which is a useful direction of thinking.

### SUMMARY OF THE INVENTION

An object of the present invention is to provide a physiological signal sensing devices and sensing methods in order to improve the accuracy of ECG records and make it easy to operate.

In order to concretely describe the present invention, a physiological sensing device is provided, which includes:

2

two sensing units connected to two palms of a subject respectively for receiving a first ECG signal;

a filter unit for generating a second ECG signal by filtering the first ECG signal;

5 an amplify unit for generating a third ECG signal by amplifying the second ECG signal;

an analog to digital conversion unit for converting the third ECG signal to a digital signal;

10 an operating unit, comprising: a QRS wave sieving unit for sieving a plurality of consecutive QRS waves from the digital signal;

a heart beat measurement unit for generating a heartbeat cycle signal according to the QRS waves;

15 a time-domain analysis unit for generating a time-domain analysis data according to the heartbeat cycle signal;

a Fourier analysis unit for generating a Fourier analysis data, according to the heartbeat cycle signal;

a PQRST wave sieving unit for sieving a plurality of consecutive PQRST waves from the digital signal; and

20 a PQRST wave analysis unit for generating a ECG analysis data according to the PQRST waves; and

a display unit for displaying the time-domain analysis data, the Fourier analysis data and the ECG analysis data.

25 According to another embodiment, the present invention provides a sensing method of a physiological sensing device, comprising the steps of:

connecting the physiological sensing device to two palms of a subject respectively through two sensing units for receiving a first ECG signal;

30 generating a second ECG signal after filtering the first ECG signal;

generating a third ECG signal after amplifying the second ECG signal;

converting the third ECG signal into a digital signal;

35 sieving a plurality of consecutive QRS waves from the digital signal;

generating a heartbeat cycle signal according to the QRS waves;

40 generating a time-domain analysis data according to the heartbeat cycle signal;

generating a Fourier analysis data according to the heartbeat cycle signal;

sieving a plurality of consecutive PQRST waves from the digital signal;

45 generating a ECG analysis data according to the PQRST waves; and

displaying the time-domain analysis data, the Fourier analysis data and the ECG analysis data by a display unit built in the physiological sensing device.

50 In order to better describe the features and advantages of the present invention mentioned above, embodiments will be provided below with reference to appended drawings to better describe the present invention.

### BRIEF DESCRIPTION OF THE DRAWINGS

FIG. 1 is an operation diagram of the physiological signal sensing device according to the present invention.

60 FIG. 2 is a function block diagram of the physiological signal sensing device according to the present invention.

FIG. 3 is a function block diagram of the operating unit according to the present invention.

FIG. 4 is the wave diagram of the present invention.

65 FIG. 5 is a display diagram of the analysis data according to the present invention.

FIG. 6(a)-6(f) are appearance diagrams of the physiological signal sensing device according to the present invention.

FIG. 7 is the implementation flow chart of the present invention.

#### DETAILED DESCRIPTION OF THE PREFERRED EMBODIMENTS

Each heartbeat cycle generates three distinct EKG (electrocardiogram) waves, which respectively are P wave (atrial depolarization, that is, potential difference generated by depolarization before the atrial contraction occur), QRS wave (ventricular depolarization, that is the beginning of the myocardial depolarization, which is the beginning of ventricular contraction) and T wave (ventricular re-polarization—when myocardial cells depolarize, they will be a period of time for refusing accept any further stimulation).

These waves are not action potential, but to represent the potential change between the two regions on the heart surface, which is an effect generated by mixing up a lot of the action potential of myocardial cells. For example, we can know that atrial depolarization generates a potential difference by up-deflection of EKG line; therefore, the up-deflection of EKG line reaches the maximum level when half of the atrial is depolarized.

EKG line returns back to the baseline when all of the atrial depolarize because the whole atrium area is in the same polarity. Hence atrial depolarization causes P wave. The action potential is transmitted to ventricular and establish a similar potential difference, which causes a rapid upward deflection EKG line, and then back to the baseline after the whole ventricular is polarized. Hence, the ventricular depolarization can be represented by QRS wave. The plain period of myocardial cells action potential is equivalent to ST-segment of EKG. Finally, T-wave is generated by the re-polarization of ventricular.

ECG waveforms and their appearing times might be affected by the transmission of electrical signals changes caused by many kinds of cardiac defects. That is why we must rely on ECG to diagnose some heart diseases. Autonomic nervous system controls the body and life to maintain the physiological functions including blood pressure, heart rate, trachea resistance, perspiration, body temperature, energy metabolism, and those nerve controls can be operated unconsciousness.

Autonomic nervous system is divided into two major parts, sympathetic and parasympathetic nervous system. In general, the former is related to against environment, and the latter related to living and propagation.

For example, the excitement of former would raise blood pressure and dilates pupils, and the excitement of latter would facilitate the secretion of gastrointestinal and genital erection and so on. In general, the sympathetic and parasympathetic nerve systems are both prosper in youth and both fading in old age. However, sympathetic nerve is stronger than parasympathetic nerve in male and vice versa in female. It is obvious that sympathetic and parasympathetic nerve systems have a close connection with daily work and rest of human body.

If the autonomic nervous is disorder, a variety of acute or chronic diseases might be caused, such as heart disease and high blood pressure and so on, that will in turn lead to a serious emergency case, such as sudden death. As a result, to keep autonomic nervous system healthy is an important issue in medicine.

In recent years, many new diagnostic techniques for autonomic nervous system have been successfully developed.

Due to the maturity of computer technology and spectrum analysis, autonomic nervous system functions of heart can be detected and quantified through small changes in heart rate,

that is, heart rate variability (heart rate variability, HRV) when a human body is in rest. In other words, we can analyze or diagnose a normal person's autonomic nervous system function without interfering in his daily routine.

Some method of computing heart rate variability is analysis in the time-domain such as The Standard Deviation of Normal to Normal Intervals, SDNN; and some are assisted by spectral analysis.

Researchers found out that the fluctuate routes of the small fluctuations in heart rate variability can represent total power (TP). And those fluctuations may also be clearly divided into two groups, high-frequency (HF) and low-frequency (LF) components. In which the high frequency component synchronizes with animal's respiratory signal, so it is also known as the respiratory component. Low-frequency component is conjectured to have a connection with blood vessels movement and pressure sensing reflex. Some scholars further divide low-frequency component into very low frequency (VLF) and low-frequency components.

Referring to FIG. 1, FIG. 2 and FIG. 3, the physiological signal sensing device 10 of the present invention substantially consists of two sensor units 11 and 11', a filter unit 12, an amplifying unit 13, an analog to digital conversion unit 14, a operating unit 15 and a display unit 16.

The two sensor units 11 and 11' are attached to two palms of a subject (or a human being) 20 or held in hands of the subject 20 respectively for receiving a first ECG signal Sig1 and Sig1' generated by user's heartbeat (Sig1 and Sig1' are left-hand and right-hand ECG signal). The filter unit 12 filters the first ECG signal, Sig1 and Sig1' to generate, and keeps the second ECG signal Sig2 from the outside interference to generate noise. The amplifying unit 13 amplifies the second ECG signal Sig2 to generate a third ECG signal Sig3, so as to facilitate follow-up treatment.

The analog to digital conversion unit 14 converts the third ECG signal Sig3 into a digital signal Sig4 (The first ECG signal Sig1 generated by user's heartbeat is analog and it is easy to compute after converting into digital signal). The operating unit 15 processes the digital signal through a series of operations to generate a plurality of analysis data Sig6, which are output by a display unit 16.

The physiological signal sensing device 10 of the present invention is mainly for measuring ECG signals from two palms. As the palm skin is the most delicate and the thinnest place of hands, so that the present invention is developed by using palm as the measuring and recording point to get the most accurate record of the electrocardiogram.

The hardware design of the present invention adopts bipolar input method, namely, to use two sensor units 11 and 11' (no matter by wire connection or direct configuration on both sides of physiological signal sensing device 10) as the input of ECG signal to enhance the intensity of ECG signal input. If setting two sensing units 11 and 11' on both sides of the physiological signal sensing device 10, both sensing units 11 and 11' are dry electrodes and can be constituted by metals, electrical conductivity rubber or conductor.

The way of collecting ECG signals from palms has following advantages:

1. The way of two hands fingers crossing to form a bowl-shaped allowing muscles of two hand to relax and rest, and the result of relaxation make autonomic nervous system function easy into a steady situation, without stimulating sympathetic activity by the measurement itself, so as to ensure that the measurement is more accurate.
2. As the muscles relax, the interference of EMG will also be significantly decreased.

5

3. As two hands form a bowl-shaped, it also forms a shield to fight against radio interference to reduce noise when collecting ECG signal.

4. As two hands form a bowl-shaped, it can cover the surrounding light so that the ECG display on-screen will be cleared and in addition, keeping the privacy of individuals due to spectators will not easy to see the individual physiological signal.

The operating unit **15** substantially consists of a QRS wave sieving unit **151**, a heartbeat cycle measurement unit **152**, a time domain analysis unit **153**, a Fourier analysis unit **154**, a PQRST wave sieving unit **155** and a PQRST wave analysis unit **156**.

QRS wave sieving unit **151** sieves a plurality of consecutive QRS waves from the digital signal. The heartbeat cycle measurement unit **152** generates a heartbeat cycle signal based on the QRS waves. The time-domain analysis unit **153** generates a time-domain analysis data based on the heartbeat cycle signal. The Fourier analysis unit **154** generates a Fourier analysis data based on the heartbeat cycle signal. The PQRST wave sieving unit **155** sieves a plurality of consecutive PQRST waves from the digital signal and the PQRST wave analysis units **156** generates an ECG analysis data based on the PQRST waves. The Time-domain analysis data, the Fourier analysis data and the ECG analysis data are the basic data of the analysis data Sig6.

In addition, the physiological signal sensing device **10** is configured with an extension unit **17** for allowing to insert a memory card for storing the time-domain analysis data, the Fourier analysis data and the ECG analysis data of the subject **20** after measuring for future comparison.

Further, the physiological signal sensing device **10** is configured with a switch unit **18** for switching the information shown on the display unit **16**.

Also, the physiological signal sensing device **10** is configured a battery unit **19** which provides electrical power for the requirement of physiological signal sensing device **10** operation. And the battery unit **19** is a lithium battery or any kind of battery which can be charged and discharged.

Referring to FIG. 4 and FIG. 2, the QRS wave sieving unit **151** sieves two consecutive digital signals Sig4 to two QRS waves, that is, two heartbeat signal of the testee.

The heartbeat cycle measurement unit **152** measures the intervals of R-R wave between two QRS waves for generating the heartbeat cycle signal, and the time-domain analysis unit **153** as well as Fourier analysis unit **154** are in accordance with the heartbeat cycle signal to process calculation.

The time domain analysis unit **153** carries out the analysis of the heartbeat cycle such as standard deviation of all NN intervals, SDNN, Standard deviation of the averages of NN intervals in all 5-minute segments of the entire recording, SDANN, the square root of the mean of the sum of the squares of differences between adjacent NN intervals, RMSSD, mean of the standard deviations of all NN intervals for all 5-minute segments of the entire recording, SDNN index, standard deviation of differences between adjacent NN intervals, SDSD, number of pairs of adjacent NN intervals differing by more than 50 ms in the entire recording, NN50 count, NN50 count divided by the total number of all NN intervals, pNN50 to generate the time domain analysis data. The time-domain analysis data will be generated and showed on the display unit **16** in FIG. 5.

The Fourier analysis unit **154** carries out the analyses of heart rhythm cycle signal for power spectrum density of the total power (Total power of HPSD, TP), extremely low frequency rhythm power spectrum density (Very low frequency of HPSD, VLF), low-frequency rhythm power spectrum den-

6

sity (Low frequency power, LF), high-frequency heart-power spectrum density (High frequency power, HF), high-frequency low-ratio (Low frequency power to HF ratio, LF/HF), low-frequency standard (normalized LF, LF %), high-frequency standard (normalized HF, HF %) to generate the Fourier analysis data as shown on the display unit **16** in FIG. 5.

The PQRST wave sieving unit **155** sieves the digital signal Sig4 into one or more PQRST waves. The PQRST wave analysis units **156** will be calculated according to the PQRST, as well as the high point of time (such as P point height ( $A_P$ ), Q point height ( $A_Q$ ), R point height ( $A_R$ ), S point height ( $A_S$ ), T point height ( $A_T$ ), RR interval of time ( $T_{PR}$ ), QT interval of time ( $T_{QT}$ ), QS interval of time ( $T_{QS}$ )), and so on to generate an ECG analysis data displayed on the display unit **16** as shown in FIG. 5.

Referring to FIGS. 6(a)-6(f), because the filter unit, amplifying unit, analog to digital conversion unit and operating unit of the present invention can be integrated into a single chip and the size of single chip is very small, this physiological signal sensing device of the present invention can be made into very thin and short form, such as FIG. 6(a)-6 (f) of card, square, round, oval, egg-and-ball shape and so on, making it easy for users to easily carry.

In addition, the physiological signal sensing devices of the present invention can also be integrated into portable electronic devices such as mobile phone, PDA (personal digital assistants), notebook computers, MP3 players, by merely embedding the single-chip into the devices above and installing two sensor units, and sharing display unit with above devices to become a multi-functional machine.

As a result, people do not need to go to hospitals for measuring ECG data. The portable electronic devices can carry out and measure. It is very convenient and practical with low manufacturing costs.

Moreover, the physiological signal sensing device can also carry out electromyography (EMG), body temperature and blood sugar detections, to detect a variety of physiological signals for the purpose of effectiveness.

Referring FIG. 7, the sensing method of physiological signal sensing device comprises the following steps: connecting two sensing units to two palms of a subject respectively for receiving a first ECG signal (S1), that is generated by the subject's heartbeats; then generating a second ECG signal (S2) by filtering the first ECG signal, such that the second ECG signal is kept from generating noise due to outside interference; and then generating a third ECG signal by amplifying the second ECG signal (S3), so as to facilitate follow-up treatment; then converting the third ECG signal to a digital signal (S4) (Due to the first ECG signal arising from the user's heart rate is analog, calculation is made easier after converting the signal into digital signal); and sieving a plurality of consecutive QRS waves from the digital signal (S5) from the consecutive digital signal; generating a heartbeat cycle signal according to the QRS waves (S6); generating a time-domain analysis data according to the heartbeat cycle signal (S7); generating a Fourier analysis data according to the heartbeat cycle signal (S8); sieving a plurality of consecutive PQRST waves from the digital signal (S9); generating a ECG analysis data according to the PQRST waves (S10); and displaying the time-domain analysis data, the Fourier analysis data and the ECG analysis data by a display unit built in the physiological sensing device (S11).

Although the present invention has been disclosed above with the embodiments, they are not intended to limit the invention. Any ordinary skilled person in this field can make some modifications and improvement without departing from

the spirit and scope of this invention. Therefore, the scope of this invention is defined by the appended claims.

What is claimed is:

1. An device for sensing a physiological signal comprises:
  - two sensing units connected to two palms of a subject respectively for receiving a first electrocardiogram (ECG) signal;
  - a filter for generating a second ECG signal by filtering the first ECG signal;
  - an amplifying unit for generating a third ECG signal by amplifying the second ECG signal;
  - an Analog to Digital converting unit for converting the third ECG signal into a digital signal;
  - an operating unit for generating a plurality of analysis data by operational analyzing the digital signal, comprising:
    - a QRS wave sieving unit for sieving a plurality of consecutive QRS waves from the digital signal, a heart beat measurement unit for generating a heartbeat cycle signal according to the QRS waves, a time-domain analysis unit for generating a time-domain analysis data according to the heartbeat cycle signal, a Fourier analysis unit for generating a Fourier analysis data, according to the heartbeat cycle signal, a PQRST wave sieving unit for sieving a plurality consecutive PQRST waves from the digital signal; and a PQRST wave analysis unit for generating a ECG analysis data according to the PQRST waves; and
    - a display unit for displaying the plurality of analysis data.
2. The device of claim 1, wherein the heartbeat cycle measurement unit measures the intervals of R-R waves between the two QRS waves for generating the heartbeat cycle signal.
3. The device of claim 1, wherein the time domain analysis unit carries out the analyses of one of the heartbeat cycle such as standard deviation of all NN intervals, Standard deviation of the averages of NN intervals in all 5-minute segments of the entire recording, the square root of the mean of the sum of the squares of differences between adjacent NN intervals, mean of the standard deviations of all NN intervals for all 5-minute segments of the entire recording, standard deviation of differences between adjacent NN intervals, number of pairs of adjacent NN intervals differing by more than 50 ms in the entire recording and NN50 count divided by the total number of all NN intervals to generate the time-domain analysis data.
4. The device of claim 1, wherein the Fourier analysis unit carries out the analysis of one of heart rhythm cycle signal for power spectrum density of the total power, extremely low frequency rhythm power spectrum density, low-frequency rhythm power spectrum density, high-frequency heart-power spectrum density, high-frequency low-ratio, low-frequency standard, high-frequency standard to generate the Fourier analysis data.
5. The device of claim 1, wherein the PQRST wave analysis units generates the ECG analysis data by calculating high points of the PQRST wave and intervals between the high points.
6. The device of claim 1, wherein the device for sensing a physiological signal is integrated into a mobile phone, a PDA, a notebook computer or a MP3 player.
7. The device of claim 1, wherein the device for sensing a physiological signal can also carry out electromyography (EMG), body temperature and blood sugar detections.

8. The device of claim 1, wherein the two sensing units are connected to the device for sensing a physiological signal by two wires.
9. The device of claim 1, wherein the two sensing units are configured on both sides of the device for sensing physiological signal.
10. The device of claim 1, further comprises an extension unit for allowing to insert a memory card for storing the time-domain analysis data, the Fourier analysis data and the ECG analysis data.
11. The device of claim 1, further comprises a switch unit for switching the information shown on the display unit.
12. A sensing method of a physiological signal sensing device comprising the steps of:
  - connecting two sensing units to two palms of a human being respectively for receiving a first ECG signal;
  - generating a second ECG signal by filtering the first ECG signal;
  - generating a third ECG signal by amplifying the second ECG signal;
  - converting the third ECG signal to a digital signal;
  - sieving a plurality of consecutive QRS waves from the digital signal;
  - generating a heartbeat cycle signal according to the QRS waves;
  - generating a time-domain analysis data according to the heartbeat cycle signal;
  - generating a Fourier analysis data according to the heartbeat cycle signal;
  - sieving a plurality of consecutive PQRST waves from the digital signal;
  - generating a ECG analysis data according to the PQRST waves; and
  - displaying the time-domain analysis data, the Fourier analysis data and the ECG analysis data by a display unit built in the physiological sensing device.
13. The method of claim 12, further comprises the step of measuring the intervals of R-R waves between the two QRS waves.
14. The method of claim 12, further comprises step of carrying out one of the analyses of heartbeat cycle such as standard deviation of all NN intervals, Standard deviation of the averages of NN intervals in all 5-minute segments of the entire recording, the square root of the mean of the sum of the squares of differences between adjacent NN intervals, mean of the standard deviations of all NN intervals for all 5-minute segments of the entire recording, standard deviation of differences between adjacent NN intervals, number of pairs of adjacent NN intervals differing by more than 50 ms in the entire recording and NN50 count divided by the total number of all NN intervals to generate the time-domain analysis data.
15. The method of claim 12, further comprises the step of carrying out one of the analyses of heart rhythm cycle signal for power spectrum density of the total power, extremely low frequency rhythm power spectrum density, low-frequency rhythm power spectrum density, high-frequency heart-power spectrum density, high-frequency low-ratio, low-frequency standard and high-frequency.
16. The method of claim 12, further comprises the step of analyzing the height of P, Q, R, S and T points of the PQRST waves and intervals between each point.

\* \* \* \* \*